

Splice Plate, three parts

RVV 110.400 F

EAN Code: 4013339554409
 Smallest packaging unit: 5 pcs.

the photorealistic images are to be considered as reference images

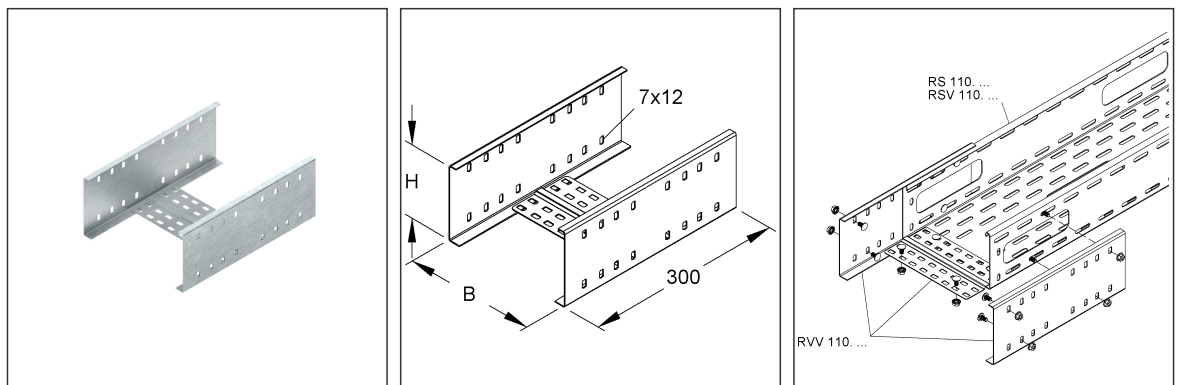
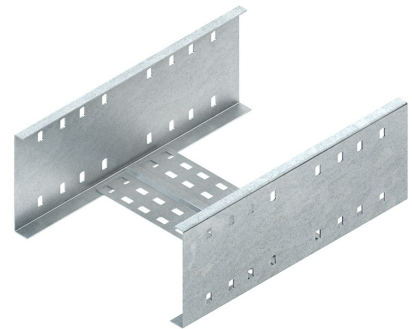

Article Description

Splice plate, three parts, 111x400 mm, steel, hot dip galvanised DIN EN ISO 1461, incl. accessories

Incl. accessories

12 FLM 6X12 F

Additional Price Information

Article group	N13
quantity unit	pcs.

Weight

Weight per quantity unit	1,471 kg/ pcs.
Weight in kg per 100	147 kg/ 100pcs.

Technical Datasheet

Cable Tray System

RVV 110.400 F

the photorealistic images are to be considered as reference images

Physical Article Dimensions

Height	114.00 mm
Width	392 mm
Depth/length	300 mm

Packing Dimension

5 pieces = 1 carton		✓ VP1-smallest packaging unit (PU)	✓ VP1-preferred PU		
Lenght	425 mm	Width	185.00 mm	Height	120.00 mm
Gross weight	7,8 kg	Volume	0,009 m ³		
Min. quantity	5.00 pcs.	Max. Quantity	5.00 pcs.		

115 pieces = 1					
Lenght	750 mm	Width	750 mm	Height	730 mm
Gross weight	219 kg	Volume	0,411 m ³		
Min. Quantity	115.00 pcs.	Max. Quantity	115.00 pcs.		

Tender Text

Splice plate, three-part, for the electrical connection of heavy duty cable trays or distribution trays, including proportional fastening accessories in hot-dip galvanised , with positive longitudinal alignment at the splice.
for heavy duty cable trays/distribution trays : 110 mm edge height
RS 110. ...
RSV 110. ...
Dimensions (approx. dimensions) inside H x W : 111 x 400 mm
Spans : ≤ 5 m
Material : Steel, hot-dip galvanised acc. to DIN EN ISO 1461
NIEDAX Model No. : RVV 110.400 F
EP Material_____ EP Wage_____
Unit price/piece

Safety & Environment

REACH Date	05.11.2025
REACH Info	Conformable
RoHS Info	Conformable

Origin & International Trade

Country of origin	DE
Customs tariff number	73089059